

The Definitive collection

SWC building the future together

P101091
30mm Frame Ext
Steel Box S000003

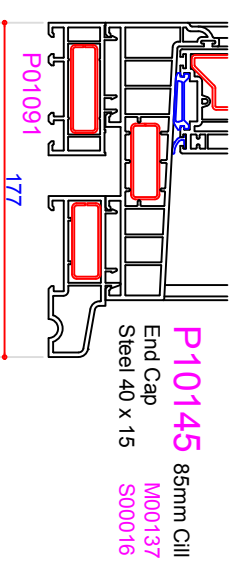

P101045 85mm Cill
M000137
S000016



P010108 120mm Cill
M000022
S000016

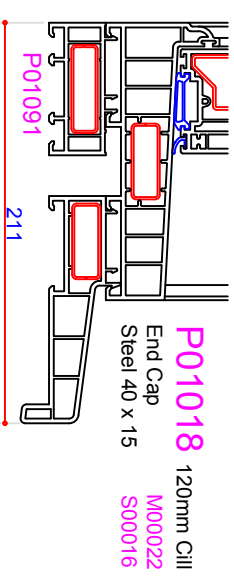

110103 150mm Cill
109006
Straight Coupler 109010
S000016

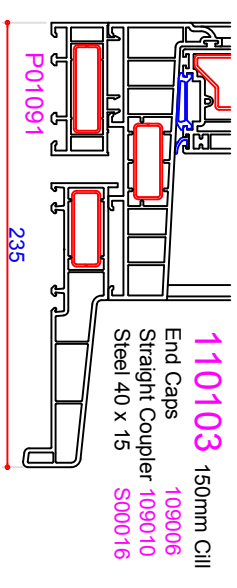

P010103 160mm Cill
M000025
S000016
M000116
M000196

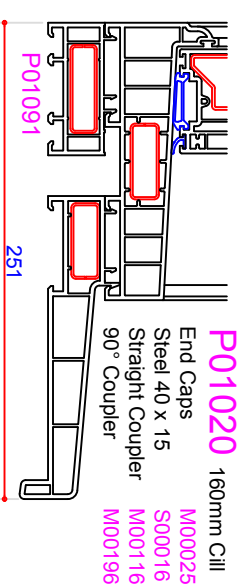

110076 180mm Cill
End Caps
Steel 35 x 19
109090
113377

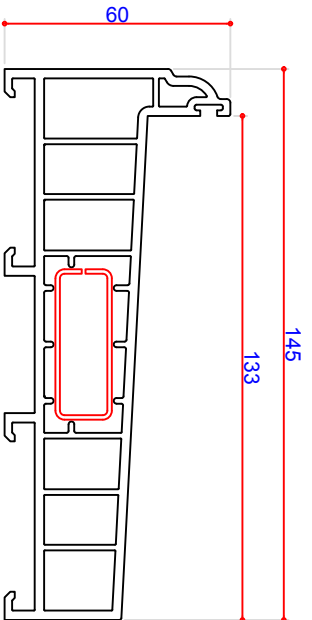
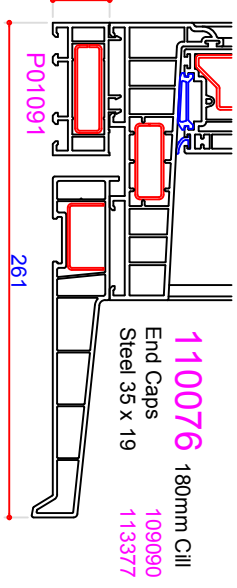

P101055 Cill
S000016 Steel Box

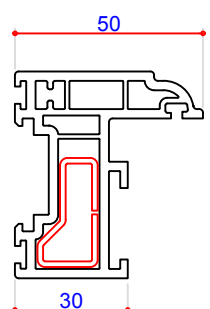

P10118 Upper Sash
S000120 Steel Box

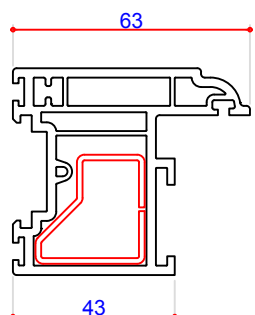

P10123 Lower Sash
S000121 Steel Box

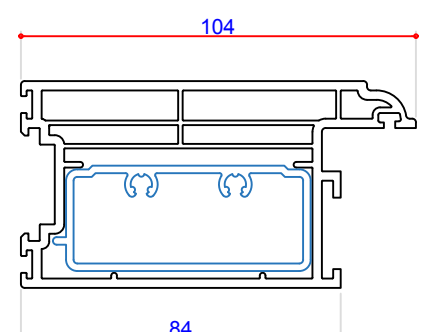

P10125 Deep Bottom Rail
A000318 Aluminium Box

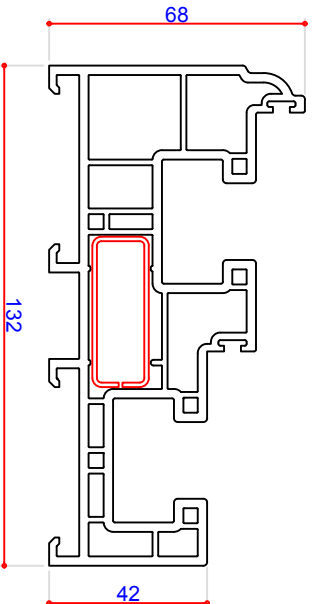

P10173 Outerframe
S000016 Steel Box

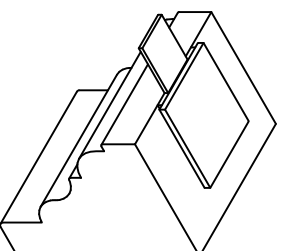

M00077 Horn

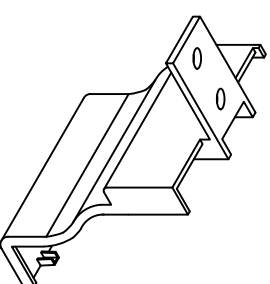

M00199 Horn End Cap

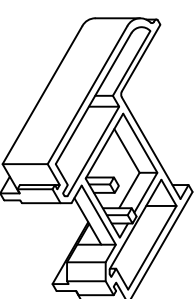

M00122 Vertical Slider End Cap
(for mechanical joint fixing)

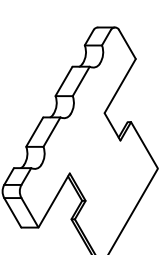

M00079 Cover End Cap
(for P10124)

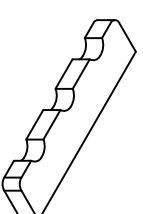

M00078 Cover End Caps
(for P10124)



M00182 Sash Block

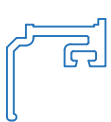

A000163
Aluminium Vent Bead

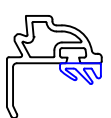

P10121
Glazing Bead



P10122
Georgian Bar



G00066
Glazing Gasket



G00042
Slider Seal



G00091
Base Seal

KEY:

 PVC Profile
 Gasket
 Steel
 Aluminium

DO NOT SCALE the drawings shown are visual representations only. VEKA PLC has the right to alter the designs, specification & descriptions without prior notice as part of our policy of continuous development and improvement.